

---

# Soracom

Mobile World Congress 2024



---

# Agenda

- About Soracom
- Wireless-Agnostic IoT
- Case studies
- Collaboration on new technologies
  - Integrated SIM (iSIM)
  - Non Terrestrial Networks (NTN)

# Soracom at a Glance

**6M** Connections<sup>(1)</sup>    **7K** Accounts<sup>(2)</sup>    **180** Countries and Regions<sup>(3)</sup>  
(Global Coverage)

## Company

**2014**  
Founded

**140** Total  
# of Employees<sup>(4)</sup>    **+50** US / Europe<sup>(5)</sup>

## Shareholders

**Ken Tamagawa**, Founder & CEO  
**Daichi Funato**, Founder, & COO  
**Kenta Yasukawa**, Founder & CTO

**KDDI** Since 2017

**SONY**

**NICIGAS**

**HITACHI**

**SOURCENEXT.**

**SECOM**

**WiL**

### Notes:

1. Number of contracted connections as of December 31, 2022.
2. As of December 31, 2022. Number of accounts which generated recurring revenue in a month.
3. Number of countries and regions where Soracom's services are available as of December 31, 2022.
4. Permanent employees only (excluding board members) as of December 31, 2022.
5. At group companies of Soracom; Soracom Global, inc. (US) and SORACOM CORPORATION, LTD. (UK)

## Interface

**Web Management**  
User Console

**API**  
Rest API

**Access Control**  
Soracom Access  
Management

**Libraries & SDKs**  
CLI, Ruby, Swift

**Developer  
Support**

## Application

**Data collection**  
Soracom Harvest Data/Files

**Dashboards**  
Soracom Lagoon

**Edge processing**  
Soracom Mosaic

**On-Demand Video Transfer**  
Soracom Relay

**Inline Processing**  
Soracom Orbit

**Data Handling**  
Soracom Beam

**Cloud Adapter**  
Soracom Funnel

**Cloud Functions**  
Soracom Funk

**SIM Authentication**  
Soracom Endorse

**Device Management**  
Soracom Inventory

**Secure Provisioning**  
Soracom Krypton

## Networking

VPG

**Device LAN**  
Soracom Gate

**Packet Control**  
Soracom Junction

**On-demand Packet Capture**  
Soracom Peek

**AWS VPC Peering**  
Soracom Canal

**Direct Connection**  
Soracom Direct

**VPN Connectivity**  
Soracom Door

**On-demand Remote Access**  
Soracom Napter

## Devices

USB Dongles / Cellular Modules / Microcontrollers / Buttons

## Connectivity

**IoT Connectivity**

Soracom Air  
for Cellular (2G, 3G, LTE) / LPWA (LoRaWAN, Sigfox, LTE-M)

**Secure Link**  
Soracom Arc

WiFi / Ethernet / Satellite / etc.

Soracom Global Platform

# Modular IoT Platform Stack

# Soracom Makes it Easy to Build IoT Services

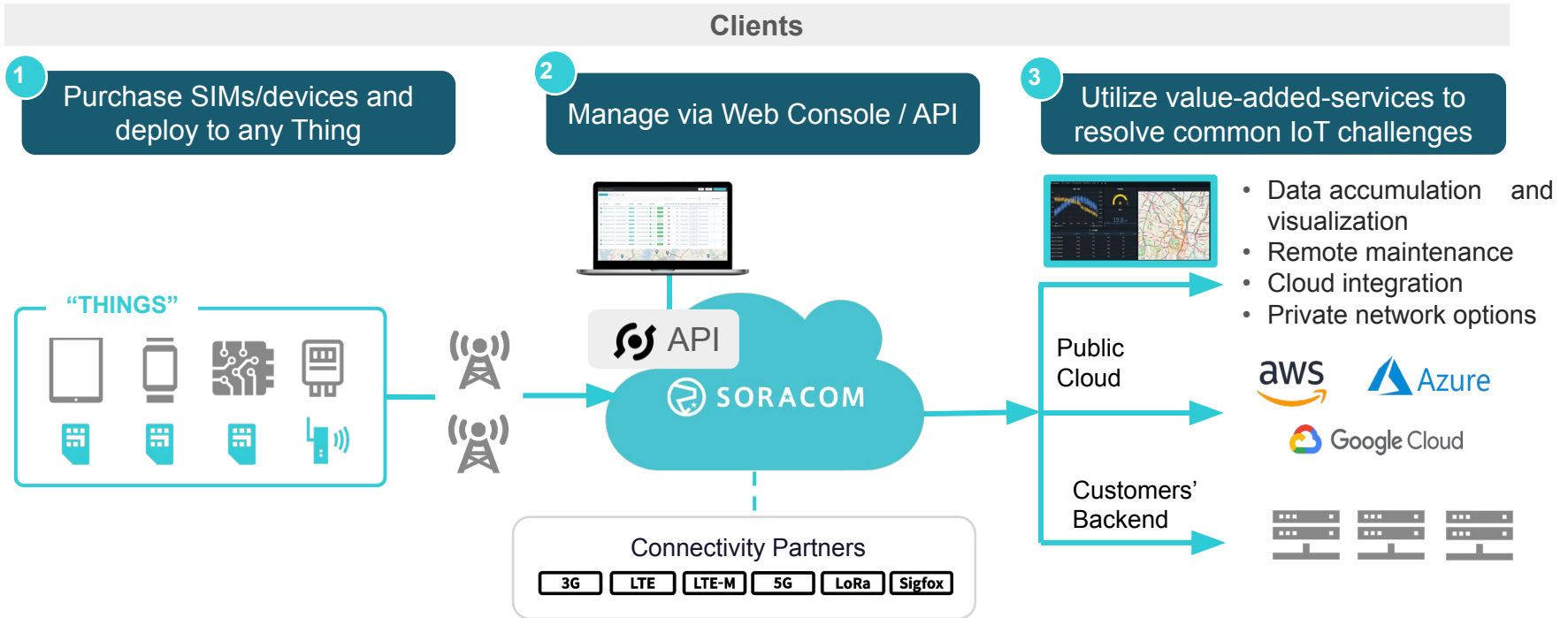

# Agnostic Brings Significant Flexibility

## Connectivity Agnostic

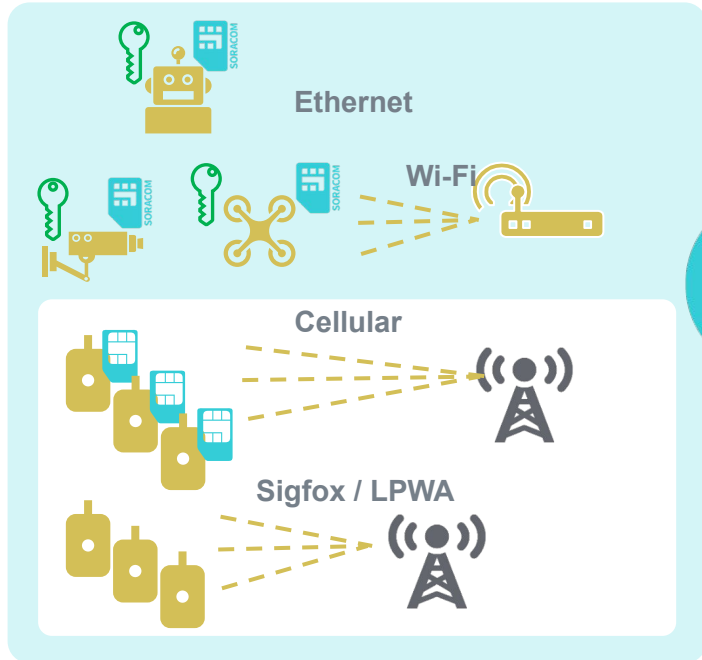

**Global  
Platformer**

## Cloud Agnostic

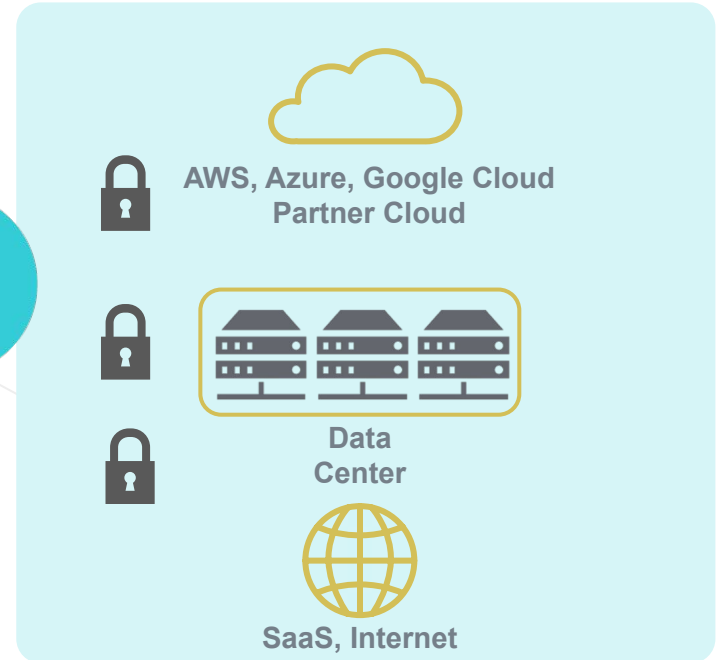

---

# Case Studies

# Case Studies

Addressing several industries specific needs

Use Cases in Japan

Local Use Cases in US / Europe

Smart Metering



NICIGAS

Remote Monitoring



SECOM

Shared Mobility



LUUP

Smart Light



YAMATO TRANSPORT

Smart-Agriculture



BeeHero

Robot



GROOVE X

Service Robot



OMRON

Delivery



Linough

Plant Monitoring



三菱重工

Pet Tracking



pebblebee

Cloud Translation



POCKETALK

GPS Tracking



MIXI

Senior Care



ZOJIRUSHI

Temperature Monitoring



Sollatek

Telehealth



RCP Remote Care Partners



# Sollatek

## Refrigeration Control

A comprehensive suite of temperature control, energy-saving, and voltage stabilizing components for commercial refrigerators using SORACOM connectivity to transmit data collected from the field.



Service: SORACOM Air (3G/4G)

SORACOM VPG (Closed NW)



---

# Hacomono

## Next-generation CRM and Reservation System

Developed an entry-exit reader that unlocks only for members, enabling unmanned operations for 24/7 fitness gyms and automating the acquisition of entry information.



Service : SORACOM Air (4G/LTE)

SORACOM Arc (Secure Link)

SORACOM Napter (Remote Access)

# Hacomono Wireless Agnostic Architecture

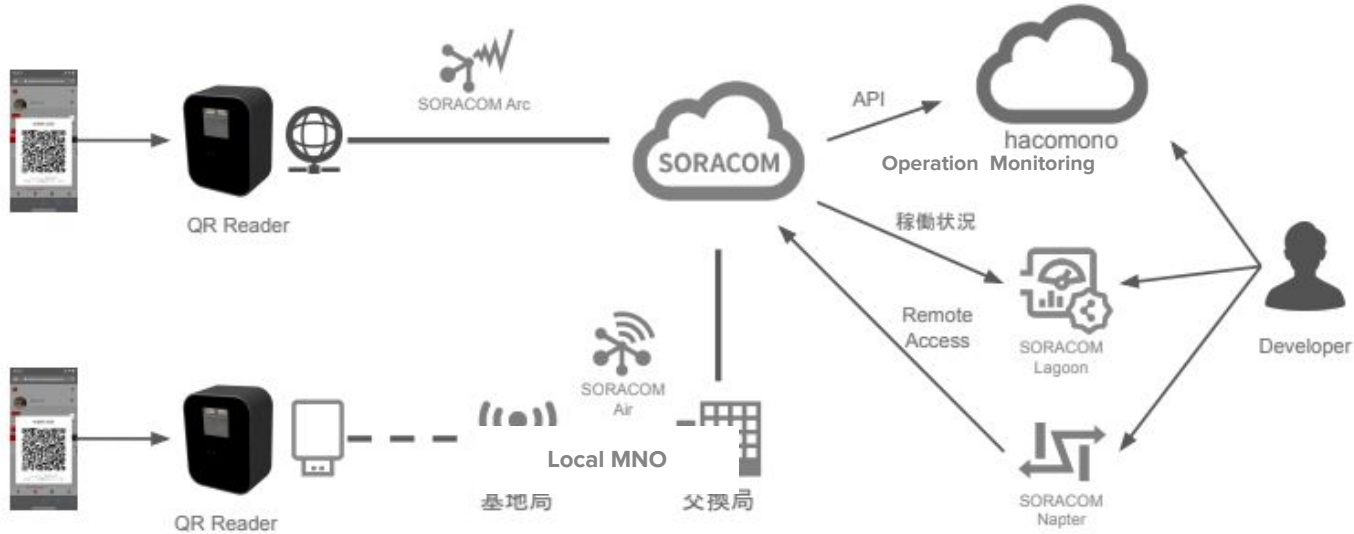

Implement customizable security access management with the ability to select existing network equipment and cellular connections based on the installation location's network environment using **SORACOM Air/Arc**.

# NIPPON Gas Co. (NICIGAS)

## Collects and transmits gas consumption data to IoT data platform

Developed a Network Connection Unit to connect gas meters to the LTE-M and Sigfox networks, enabling remote meter reading and anomaly detection. Optimize the entire process from gas filling to delivery by utilizing data.



Service: SORACOM Air (Sigfox/LTE-M)

SORACOM Funnel (Data Transmit)



# Nicigas Wireless Agnostic Architecture

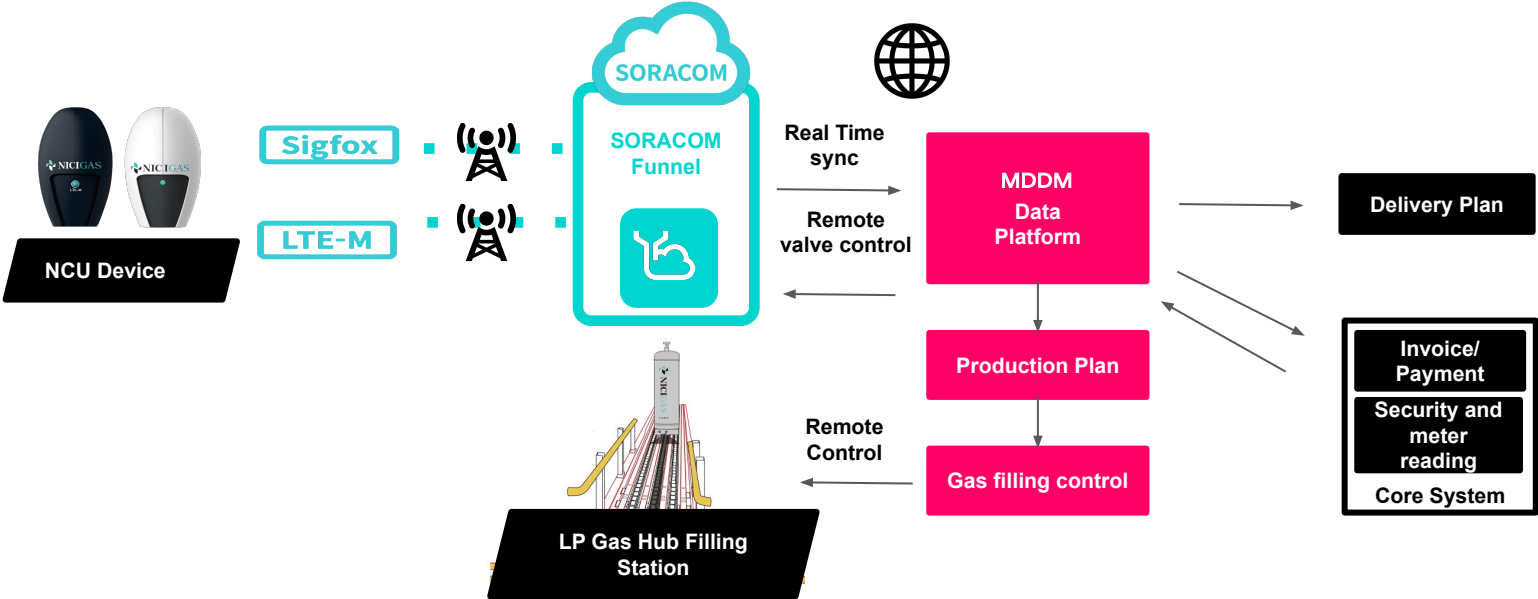

Ensuring wide coverage of data communication using Sigfox and LTE-M. Adding authentication information with **SORACOM Funnel** and enabling real-time integration with cloud.

---

# New Technologies and Collaboration

# What is iSIM(integrated SIM)?

iSIM enables SIM functionality inside a cellular SoC while maintaining the same security level reduced PCB footprint and simpler assembling.

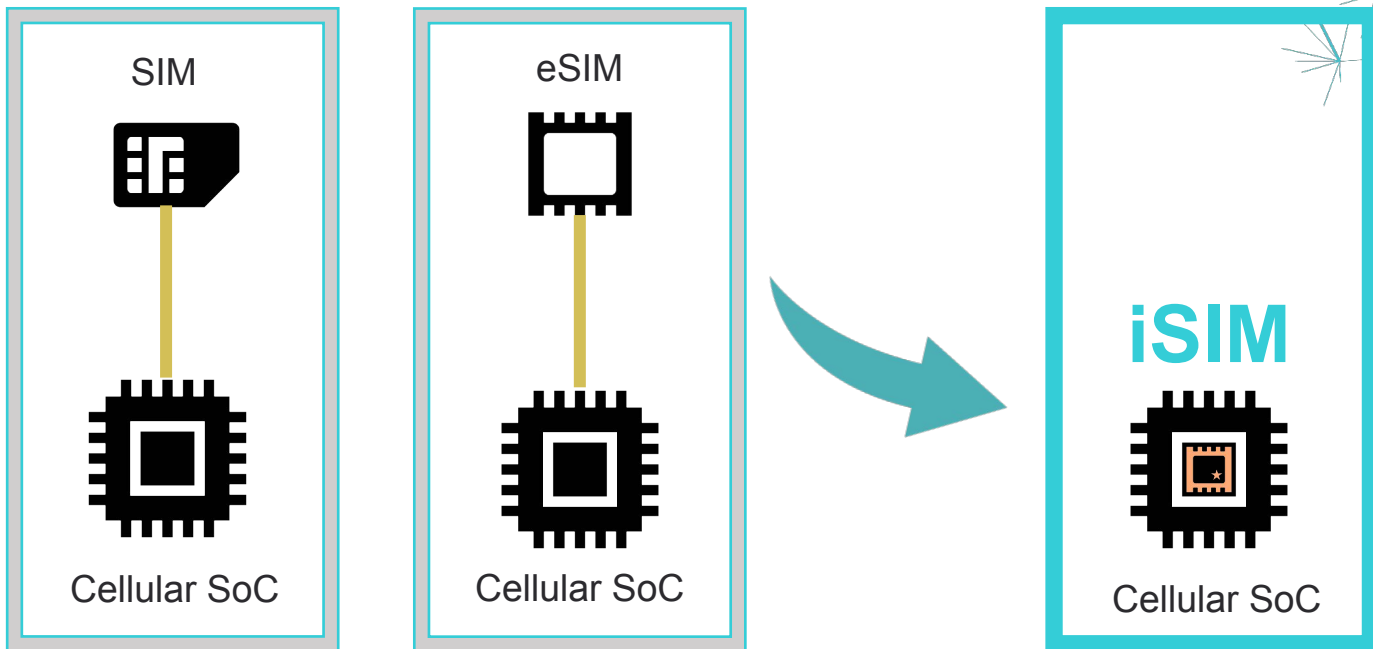

# Simplifying Complex Supply Chains

## eSIM

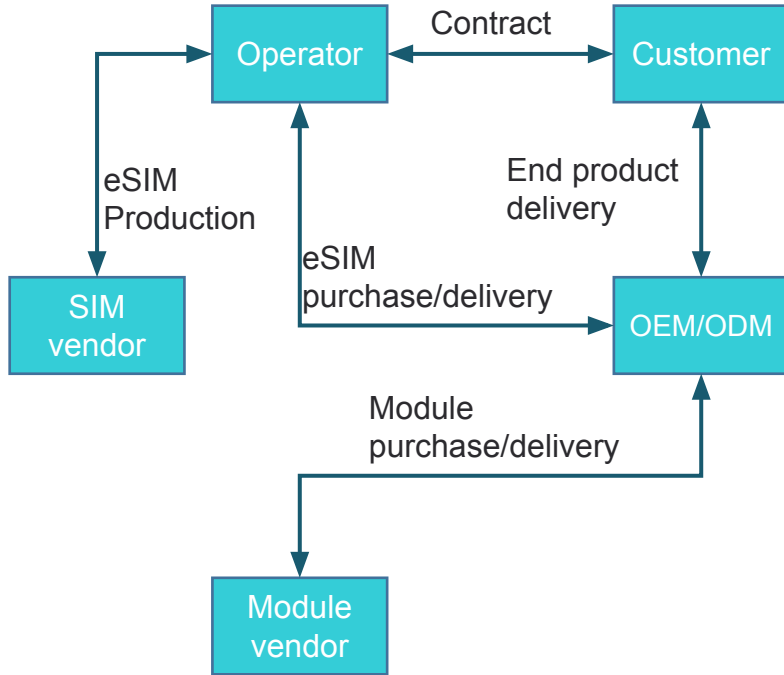

## iSIM

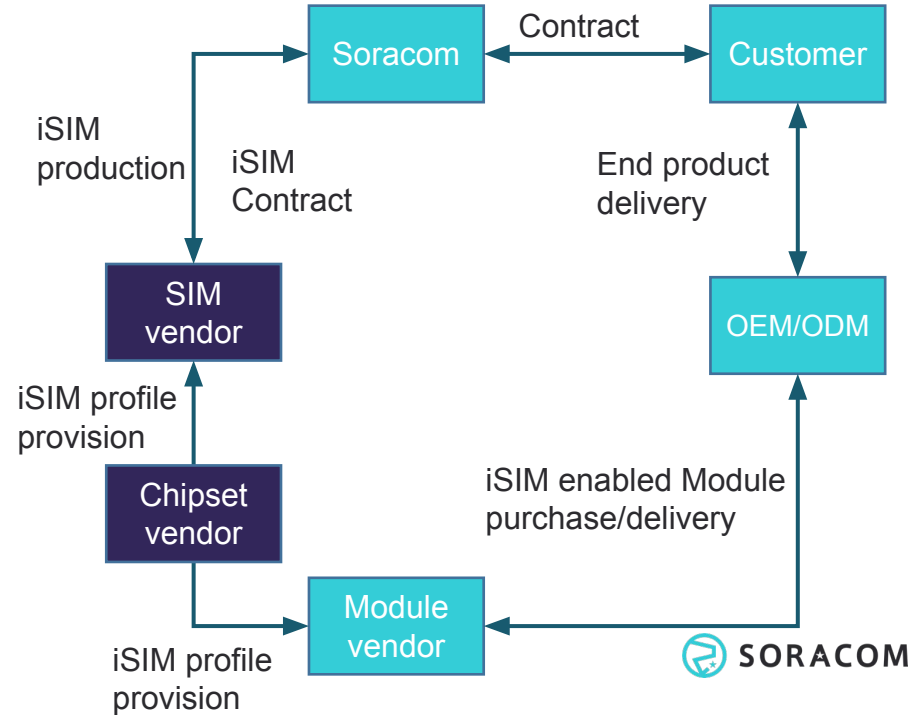



---

# Collaboration with key partners

Leveraging Kigen iSIM OS for its security and power efficiency

First iSIM-compatible modules, with Soracom global IoT plan pre-installed

- Quectel BG773
- Murata 1SC



---

# Satellite NTN NB-IoT Support - Available Now

Soracom partners with Skylo to support NTN NB-IoT

Using a R17 compliant module (Murata, Quectel), a customer can connect to both existing cellular NB-IoT and Satellite NB-IoT

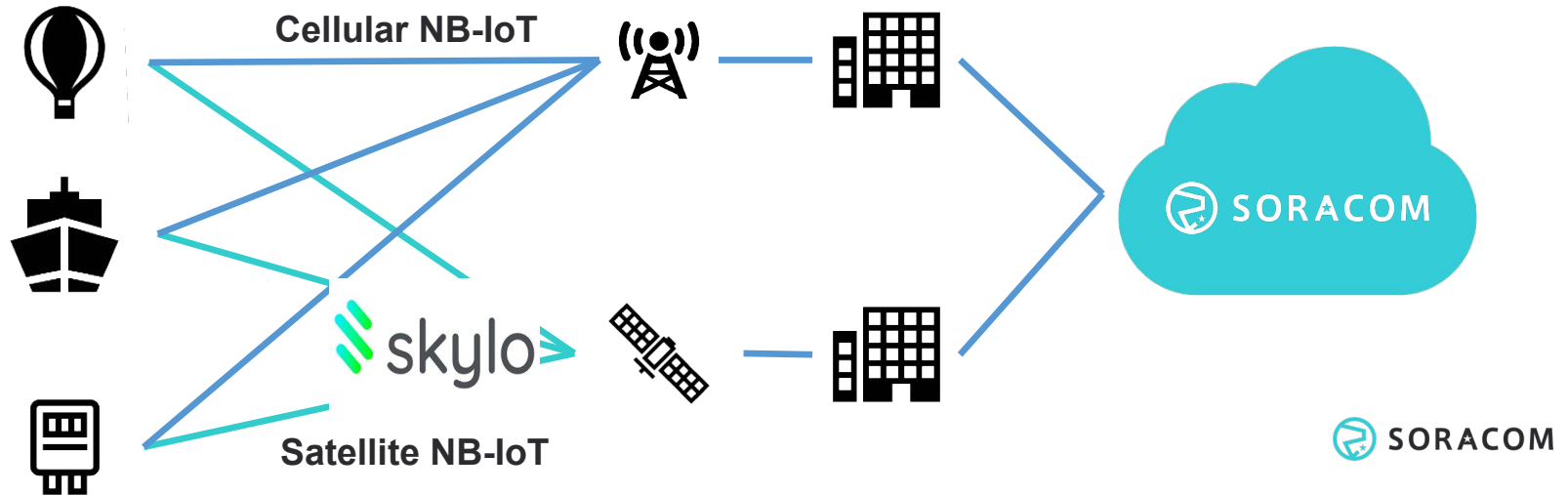

---

# Soracom Binary Parser - Optimised communications

- Parse data on the fly, enabling the use of lightweight protocol on the device side
- Depending on the use case
  - The data usage can be reduced by up to 98%
  - The power draw for each transmission can be reduced by 28%
- Key benefits
  - Longer battery life and reduced operating costs
  - Lower cost of materials, with reduced need for computing capabilities

Tested by our customer: <https://qiita.com/1stship/items/c8c6283940c1505ec918>



---

# You create. We connect.



**Takashi Serizawa (Seri)**

Sales and Marketing Director, EMEA

[seri@soracom.io](mailto:seri@soracom.io)



**Ken Otsuki**

Business Development Director

[kenny@soracom.io](mailto:kenny@soracom.io)



**Colin Shave**

Head of Sales, EMEA

[colin@soracom.io](mailto:colin@soracom.io)



**Nicolas Lesconnec**

Head of Partnerships

[nico@soracom.io](mailto:nico@soracom.io)



**Modestos Koundourzis**

Senior Carrier & Roaming Manager

[modestos@soracom.io](mailto:modestos@soracom.io)



**James Newman**

Commercial Manager, EMEA

[james@soracom.io](mailto:james@soracom.io)